

156 TYPICAL DETAIL - TYPICAL VERTICAL REINFORCING IN MASONRY WALL DETAILS
S-201

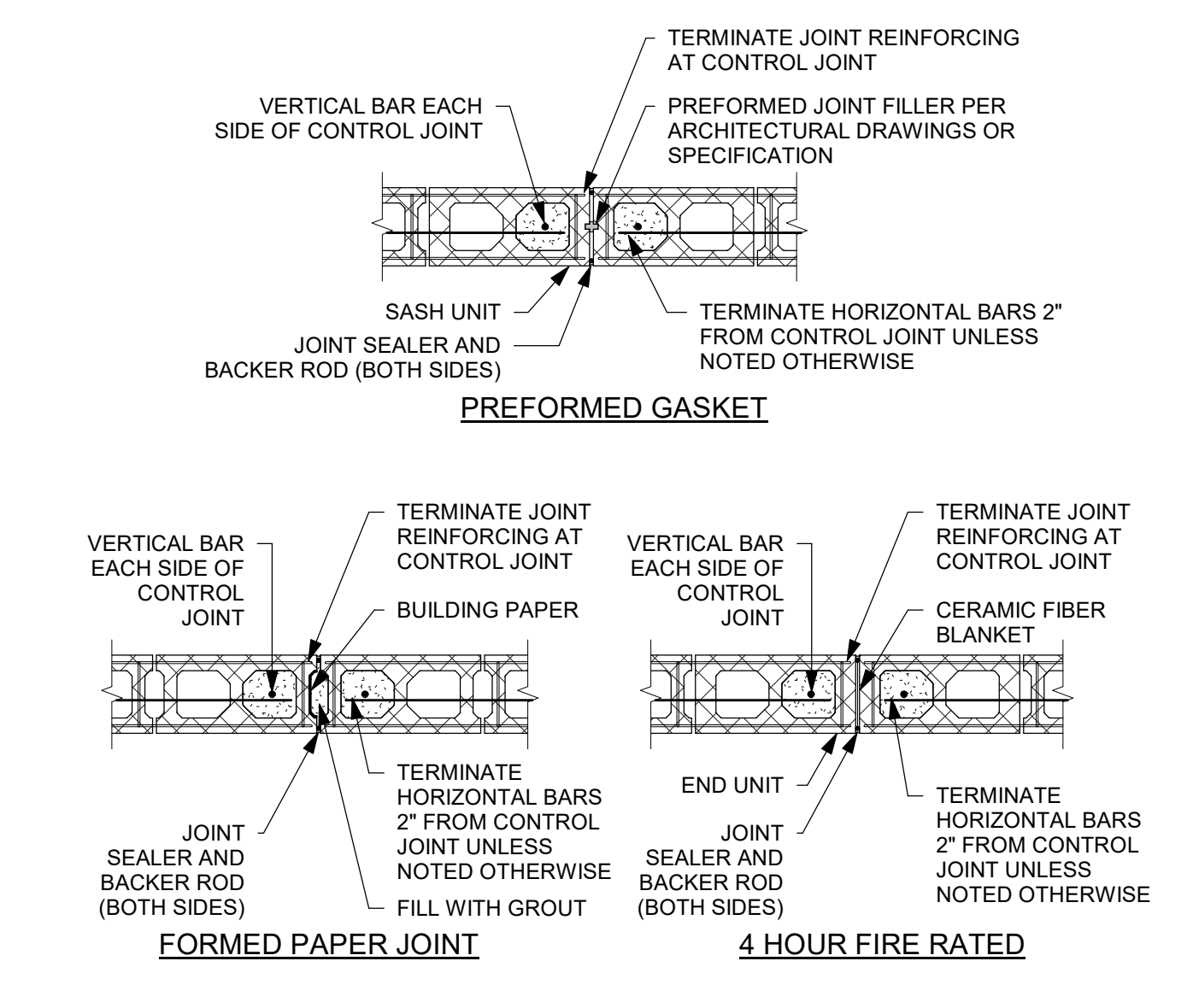

15 TYPICAL DETAIL - CMU CONTROL JOINT DETAILS
S-201

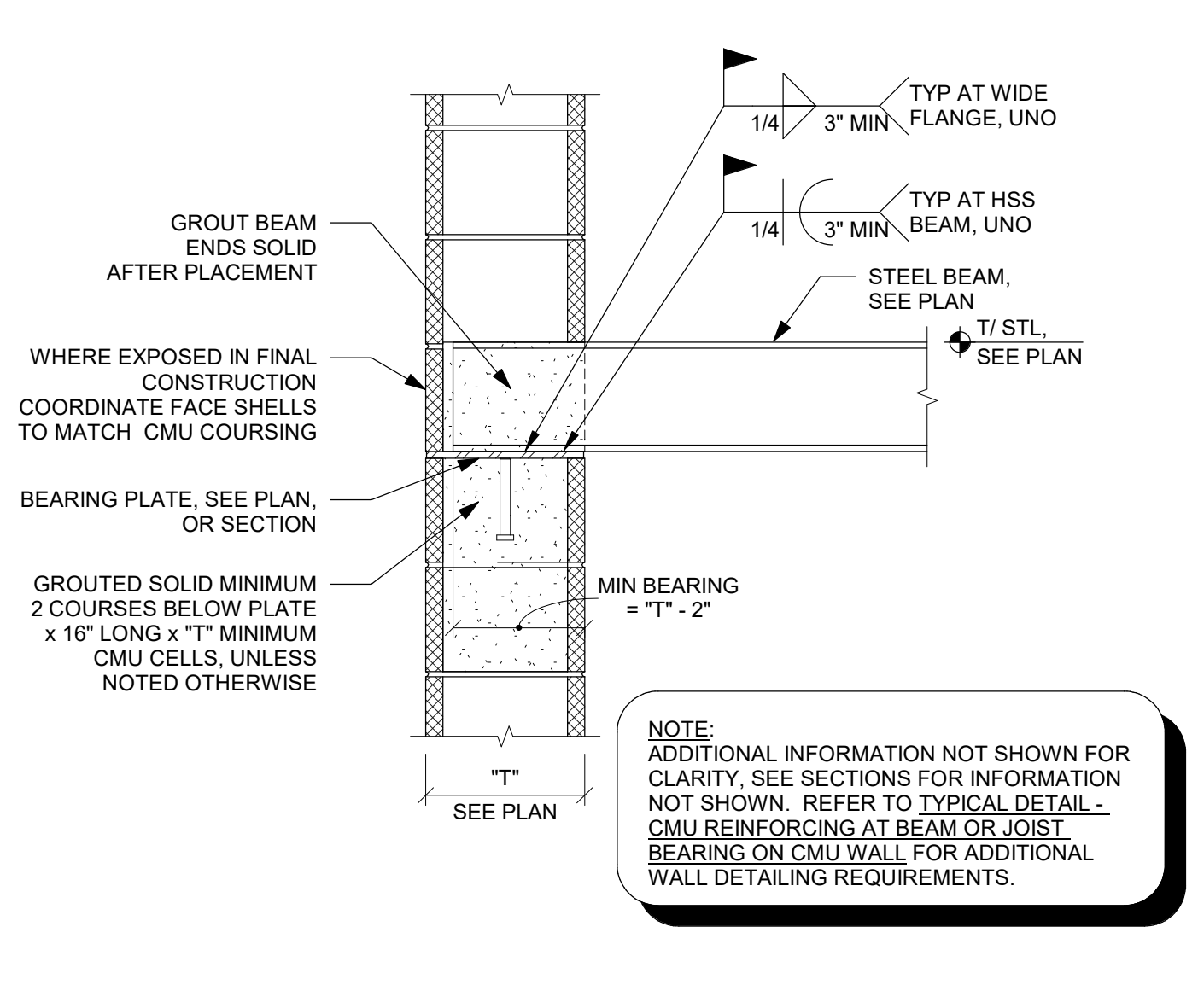

16 TYPICAL DETAIL - BEAM BEARING IN MASONRY WALL
S-201

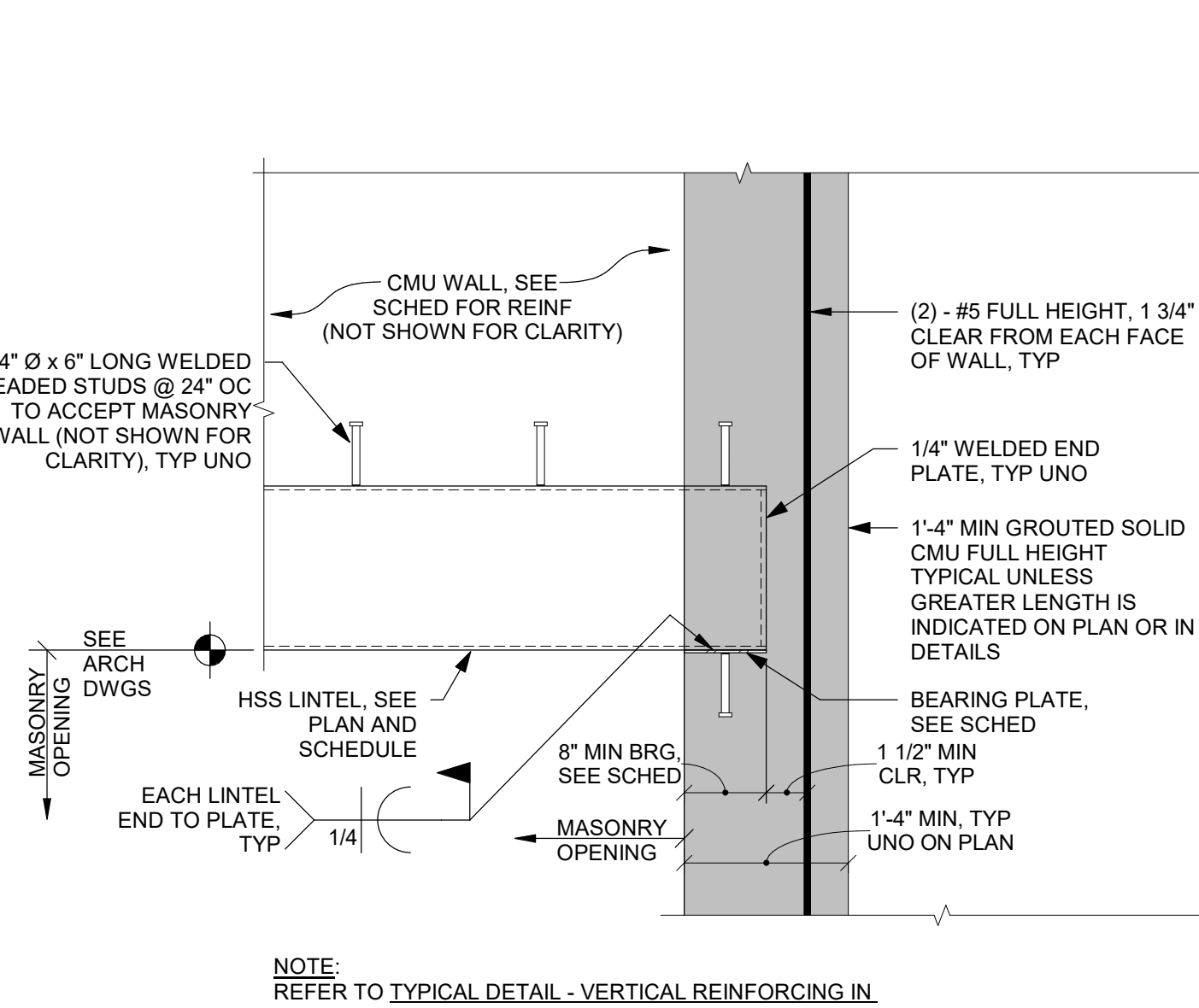

17 TYPICAL DETAIL - HSS LINTEL TO MASONRY WALL
S-201

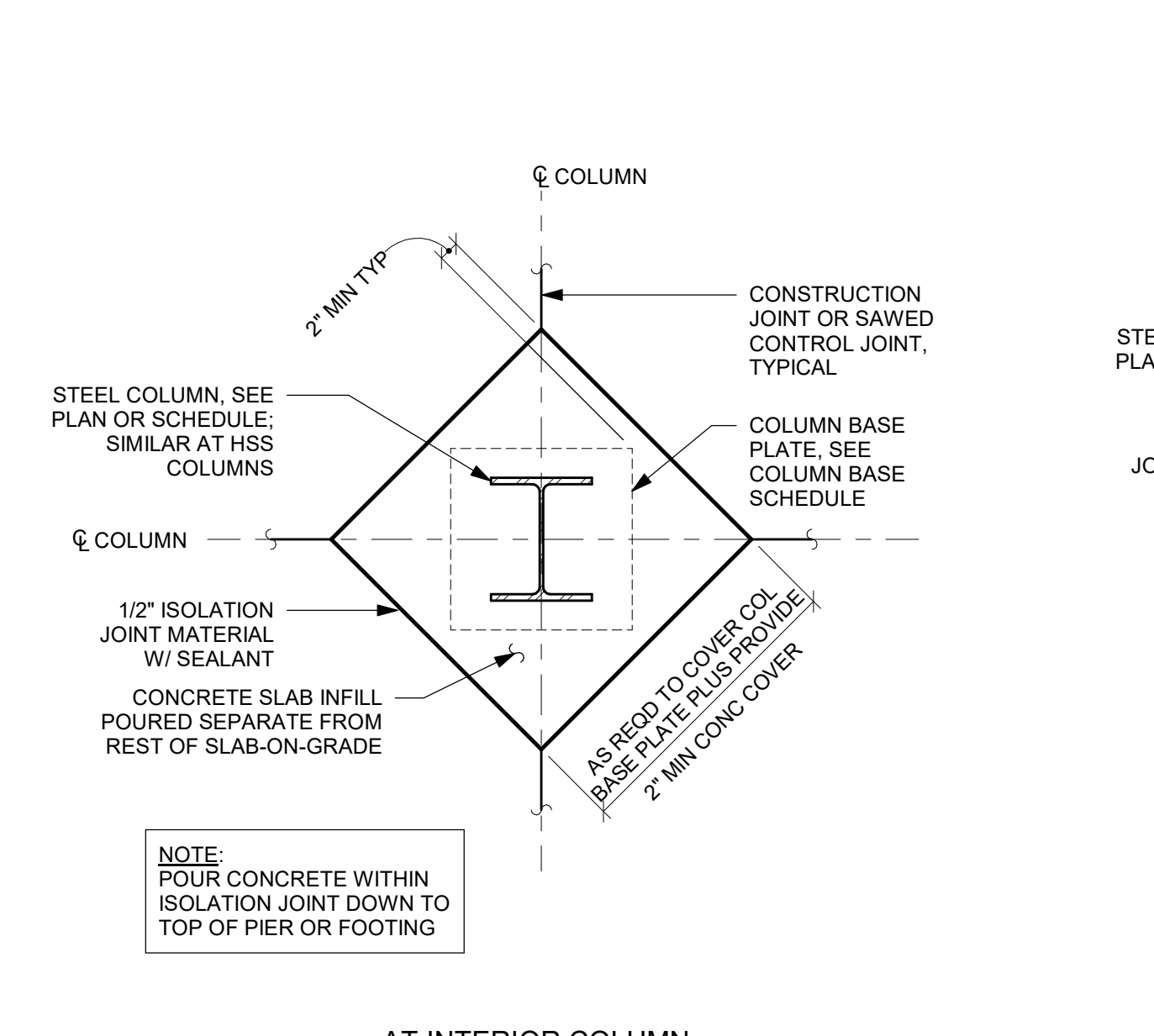

9 TYPICAL DETAIL - SLAB ISOLATION JOINTS AT COLUMNS
S-201

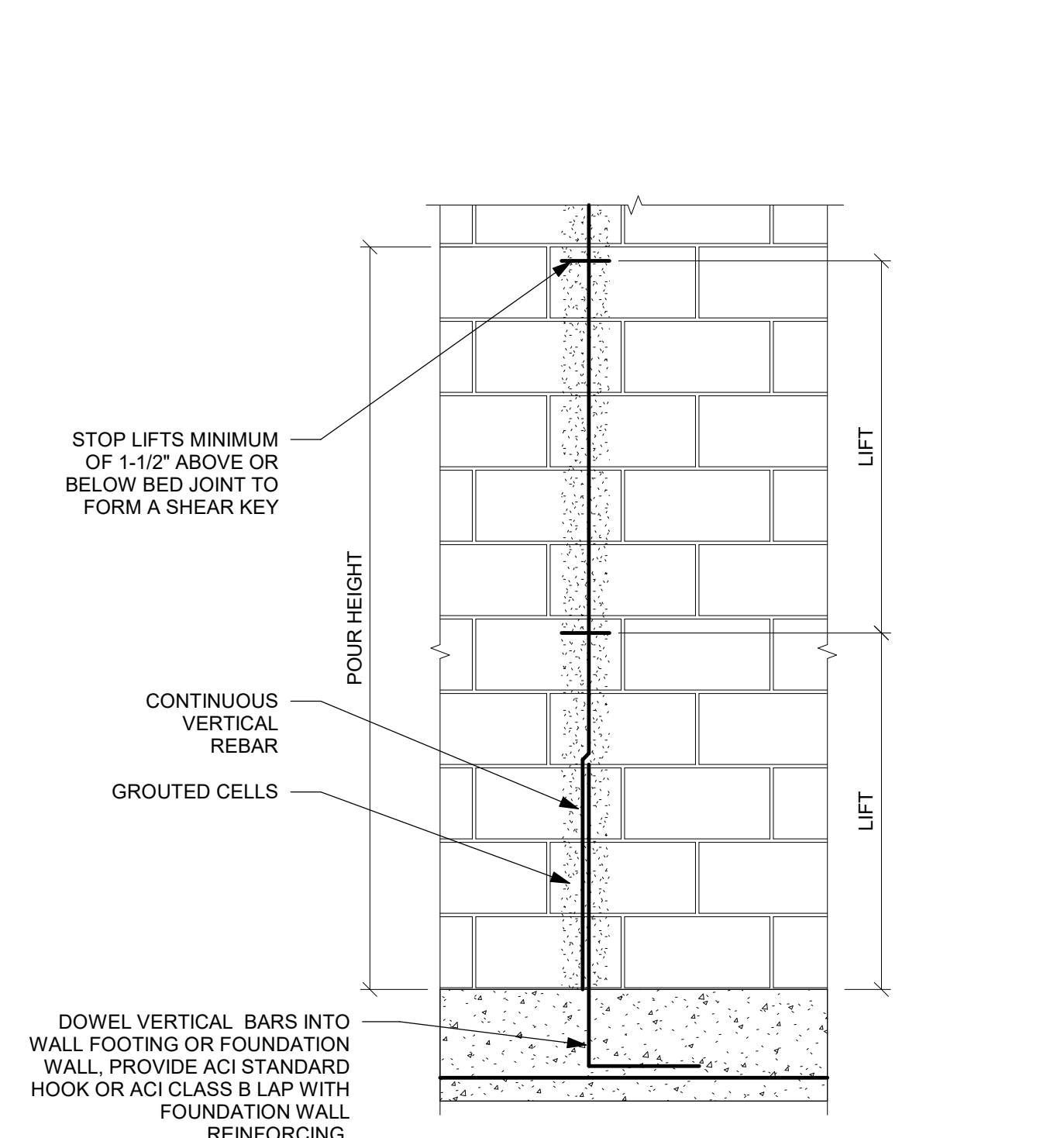

12 TYPICAL DETAIL - MASONRY GROUT REQUIREMENTS
S-201

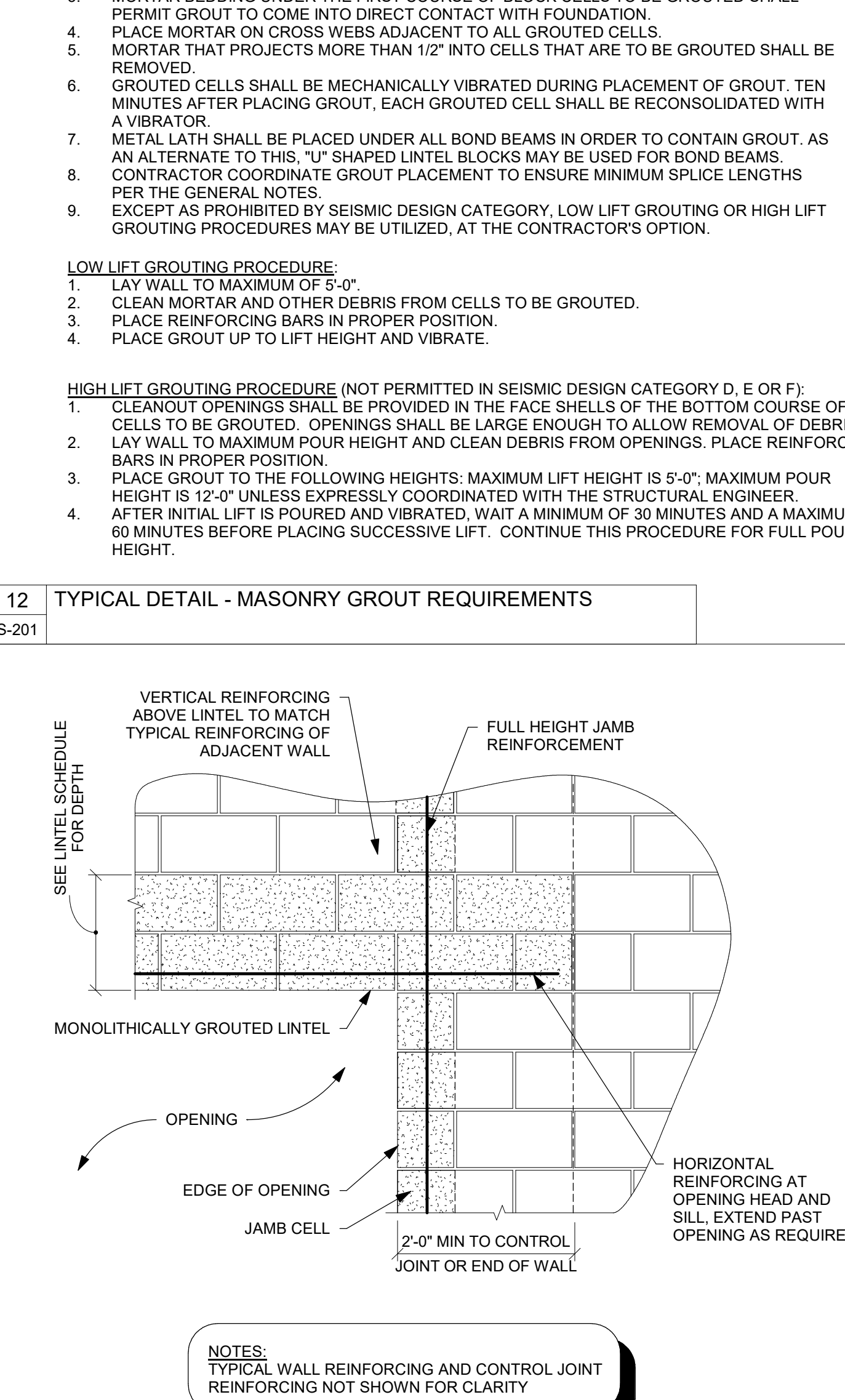

13 TYPICAL DETAIL - CMU LINTEL / JAMB CONSTRUCTION
S-201

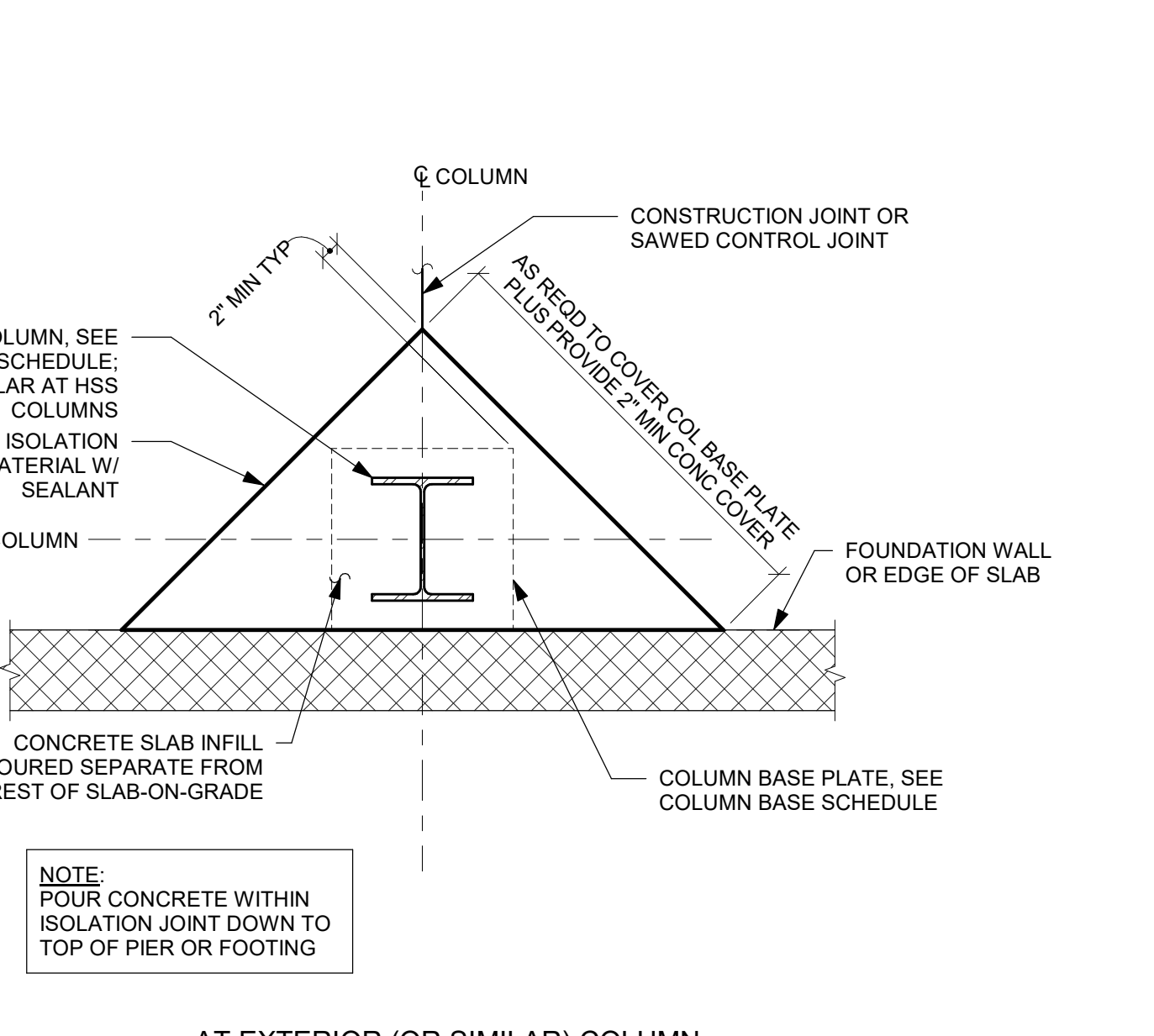

10 TYPICAL DETAIL - CONCRETE WALL JOINT PLAN DETAILS
S-201

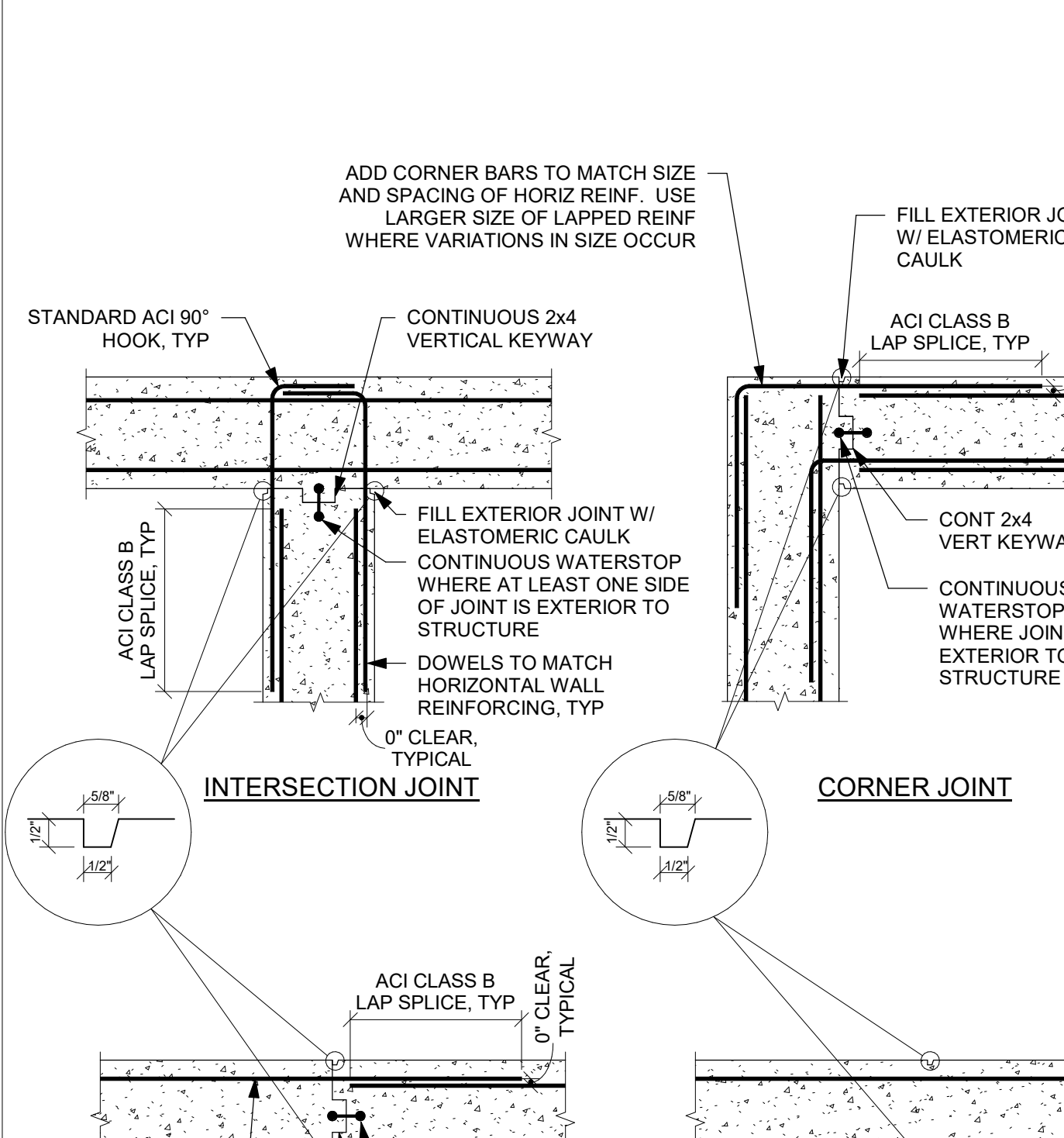

11 TYPICAL DETAIL - CMU WALL REINFORCING REQUIREMENTS
S-201

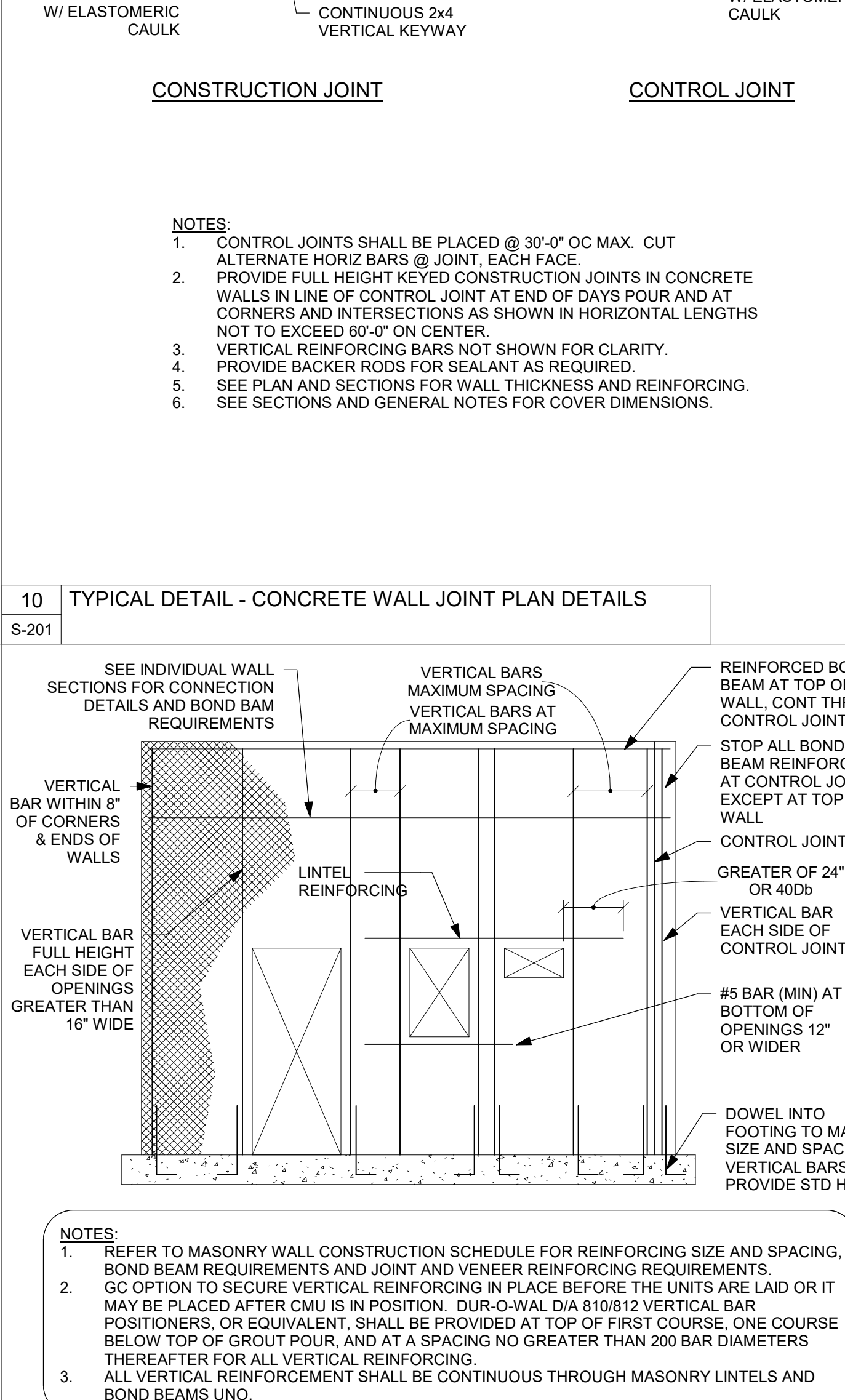

11 TYPICAL DETAIL - CMU WALL REINFORCING REQUIREMENTS
S-201

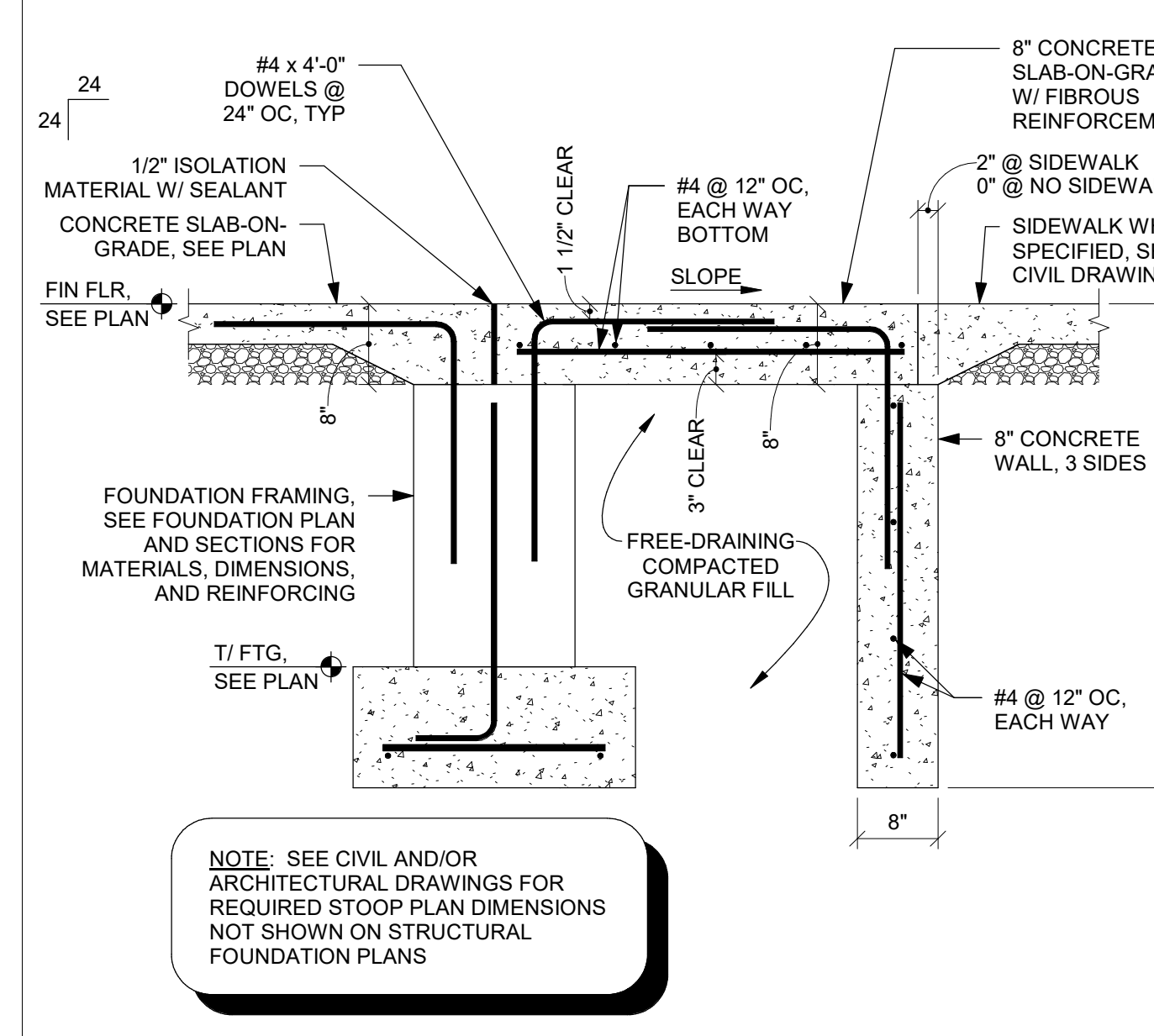

5 TYPICAL DETAIL - EXTERIOR FROST STOOP
S-201

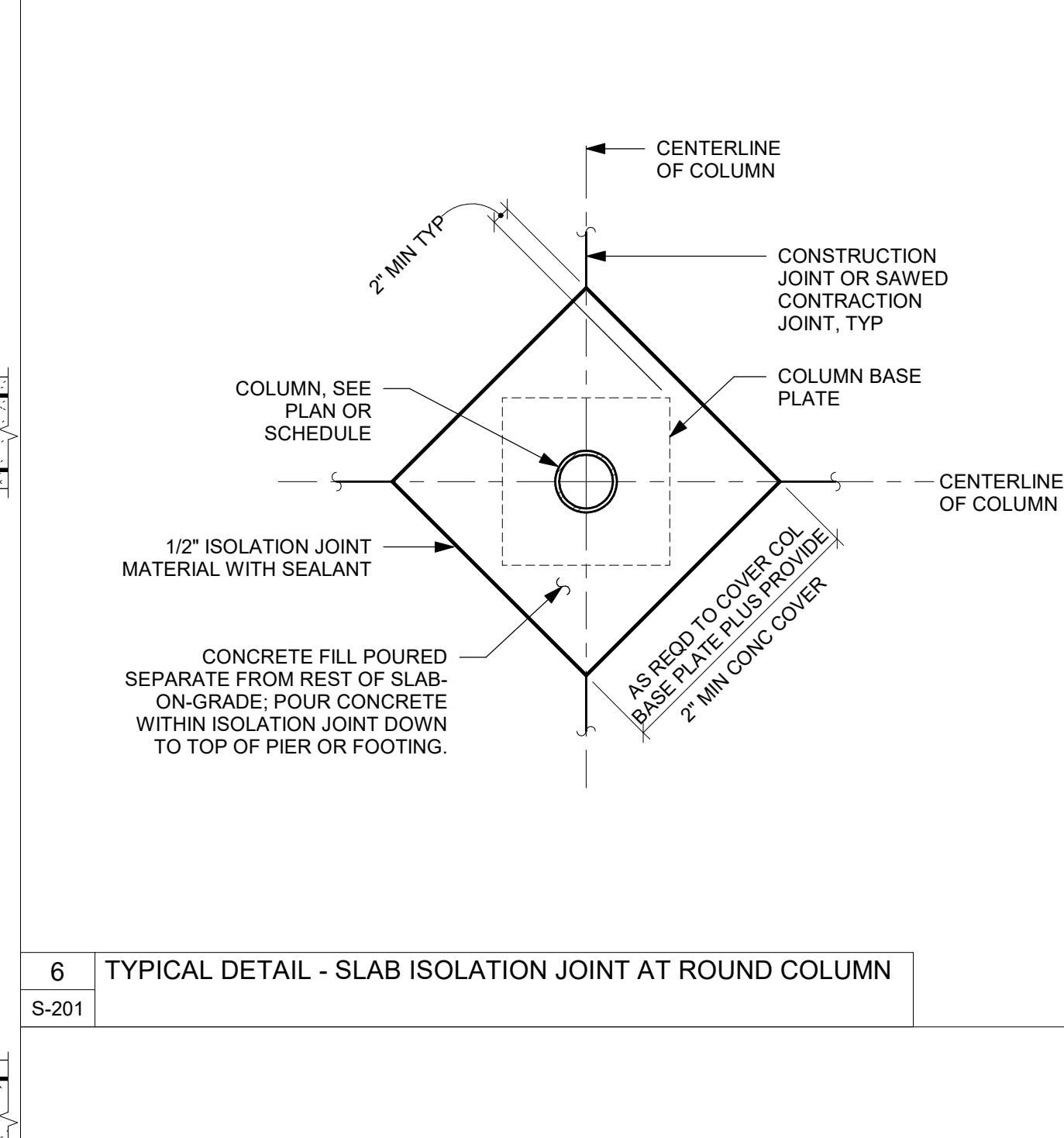

6 TYPICAL DETAIL - SLAB ISOLATION JOINT AT ROUND COLUMN
S-201

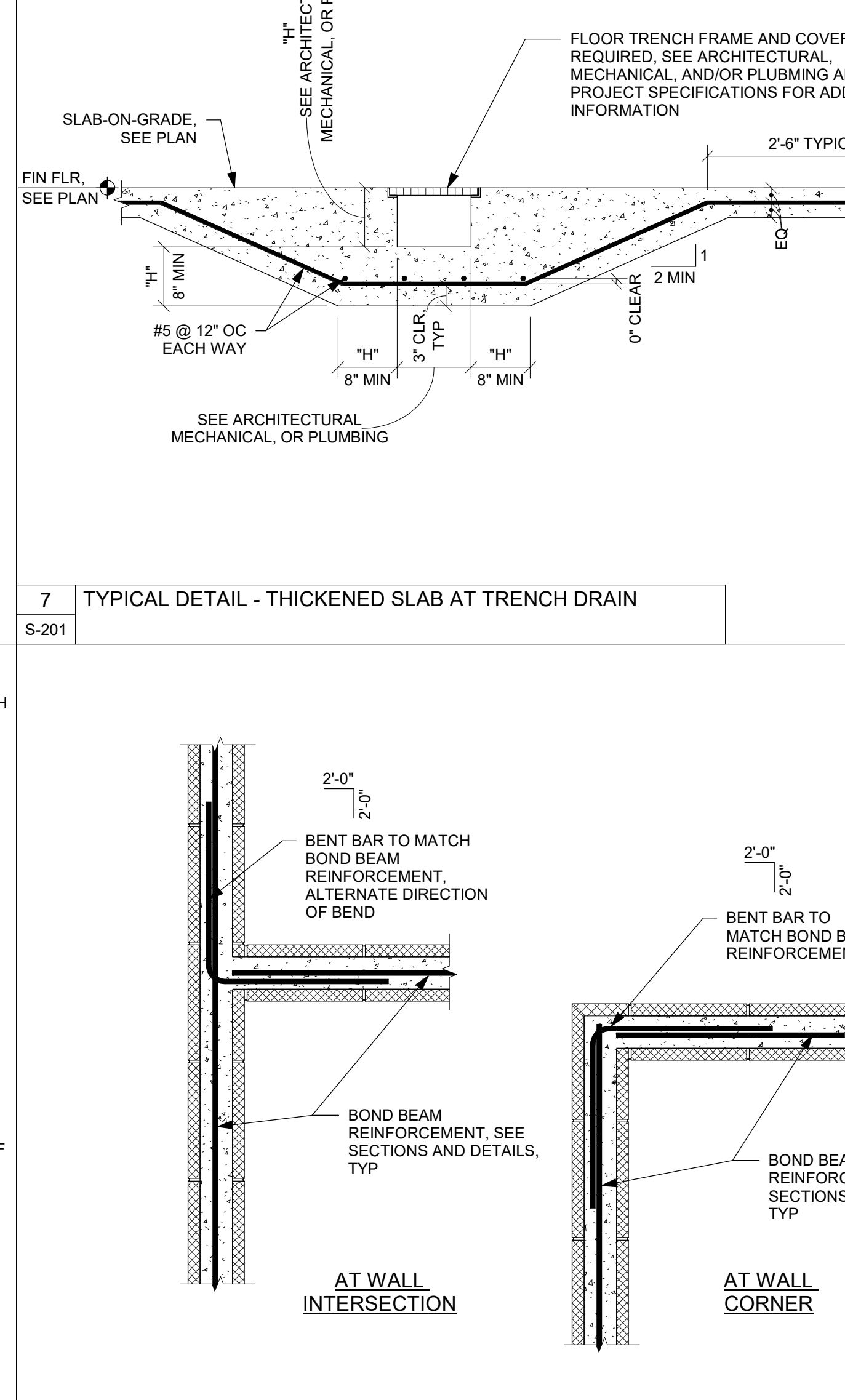

7 TYPICAL DETAIL - THICKENED SLAB AT TRENCH DRAIN
S-201

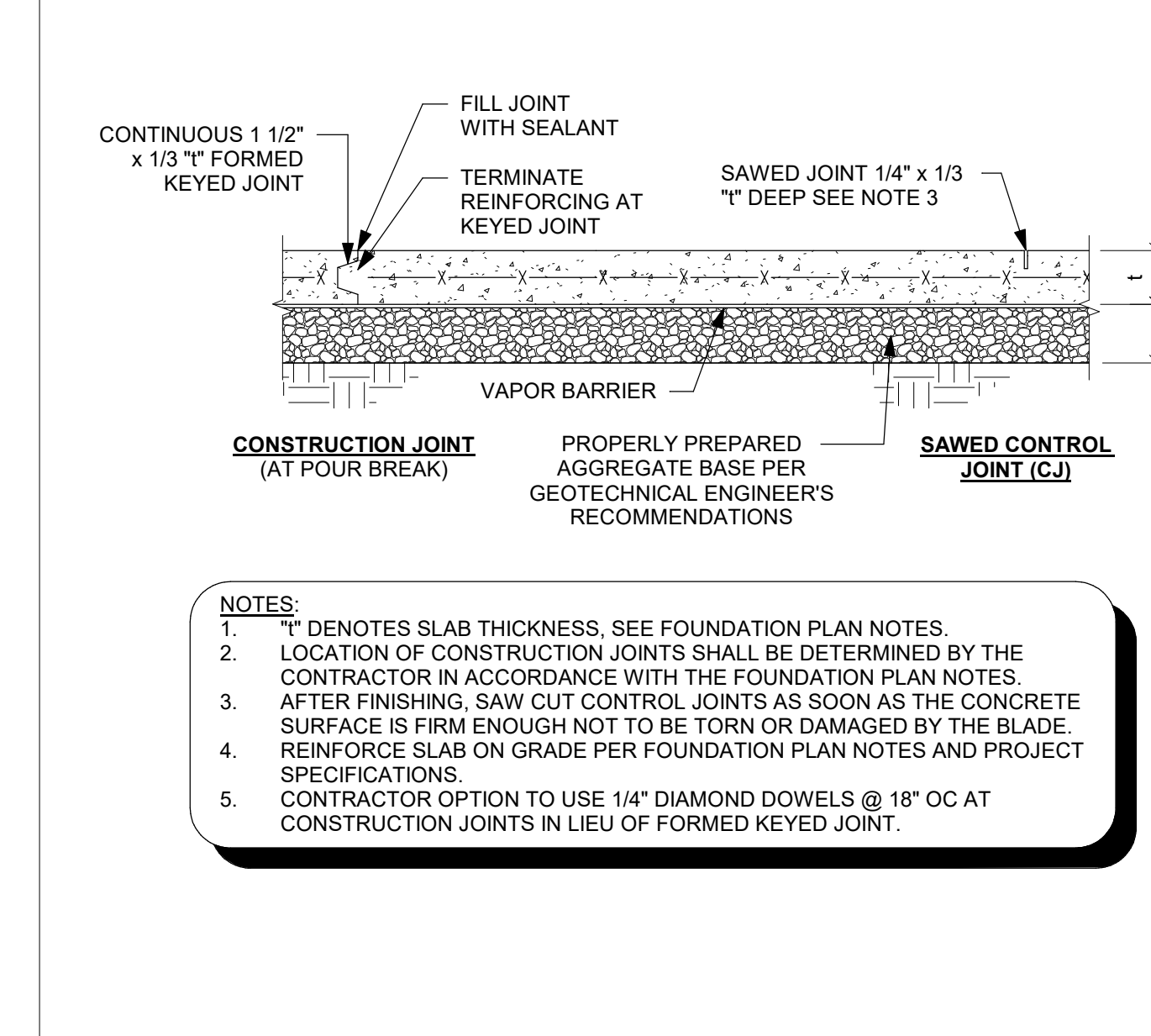

2 TYPICAL DETAIL - THICKENED SLAB AT METAL STAIR STRINGERS
S-201

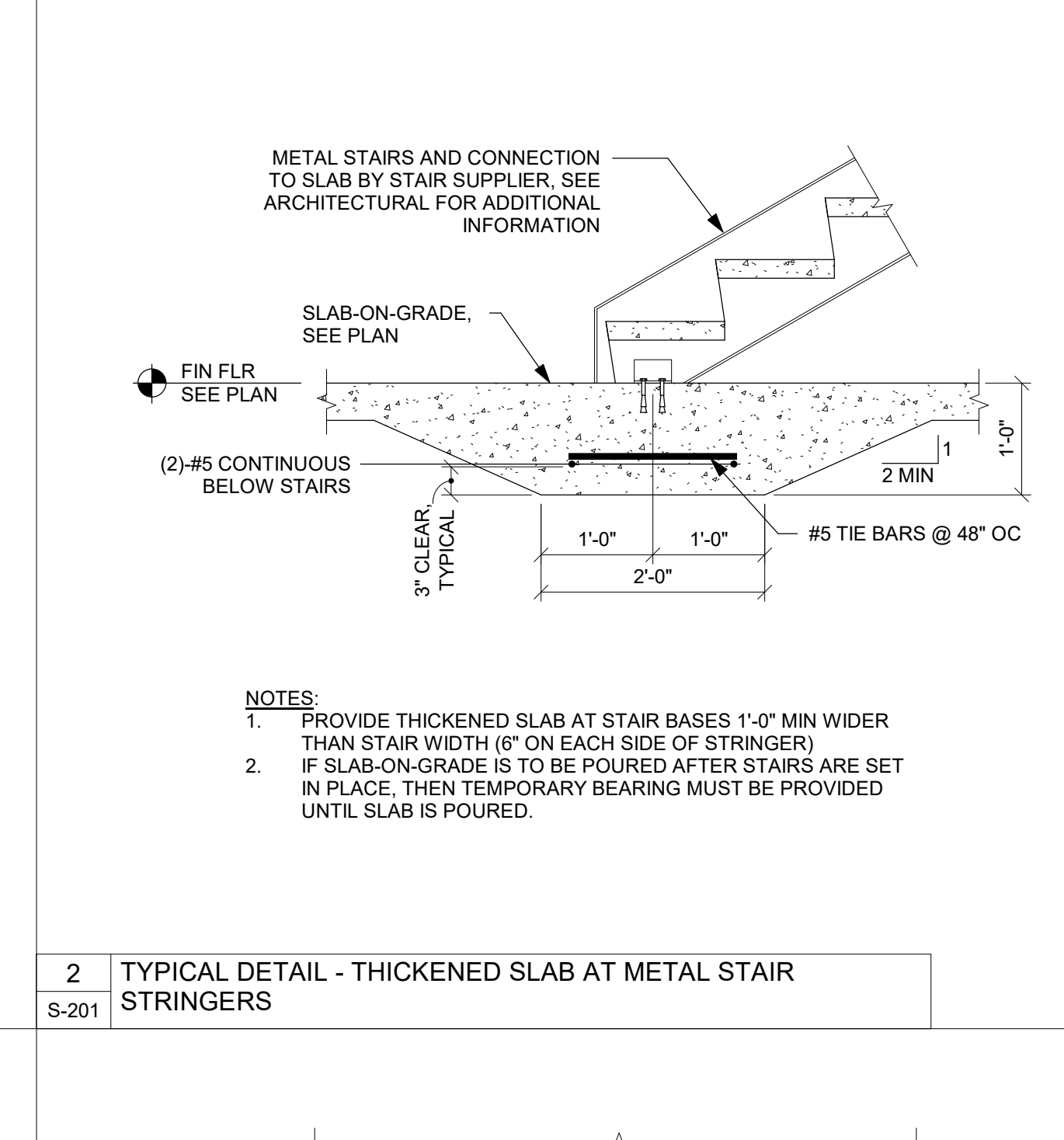

3 TYPICAL DETAIL - REINFORCING AT DISCONTINUOUS JOINTS AND RE-ENTRANT CORNERS IN SLABS-ON-GRADE
S-201

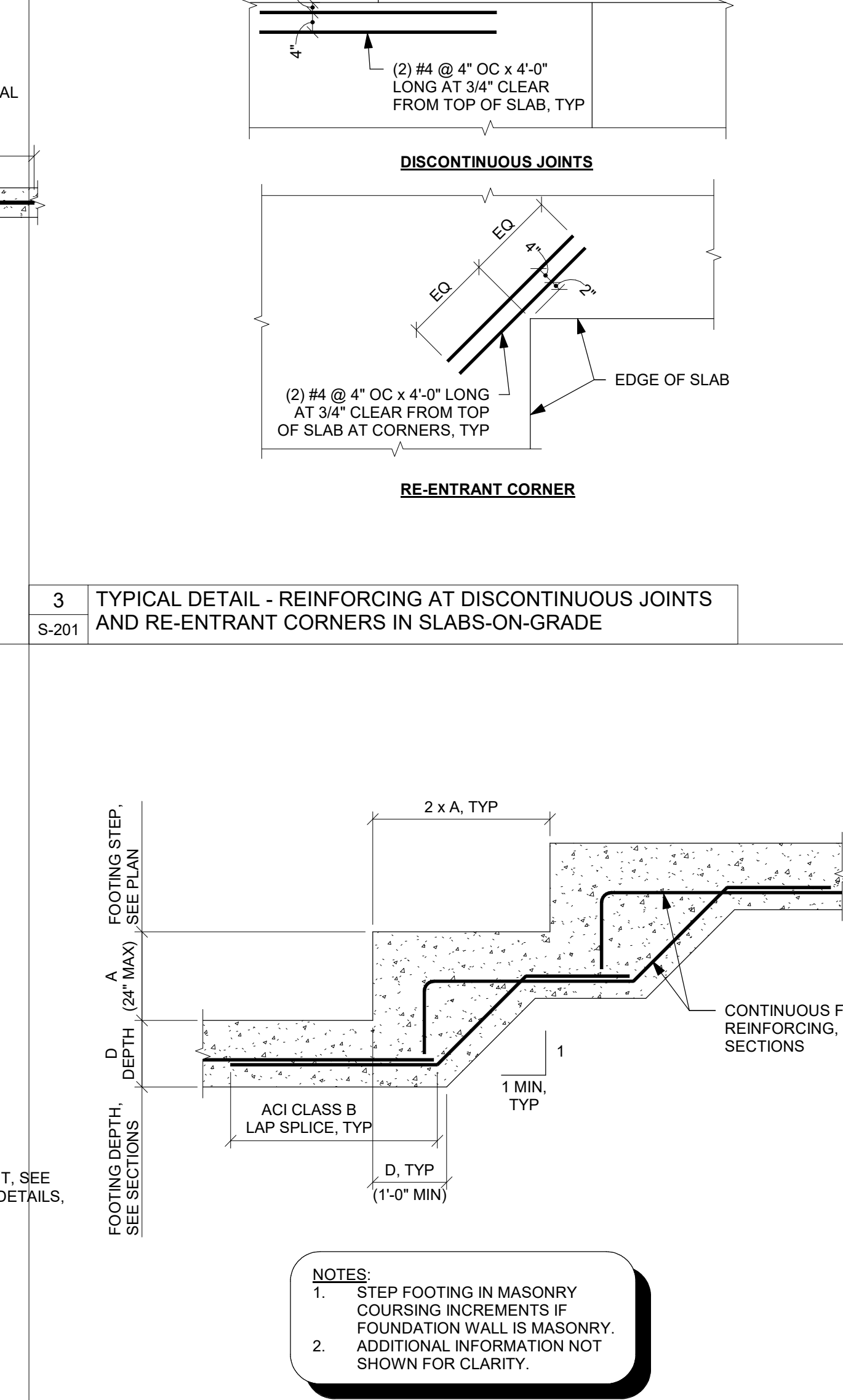

4 TYPICAL DETAIL - STEPPED FOOTING
S-201

STAHL SHEAFFER ENGINEERING
301 Science Park Road, Suite 333
State College, PA 16803
0-81-689-1262 (PA) 0-81-689-1885
www.stahlsheaffer.com (0717) 629-2024
SEE PROJECT NO. 19-42

DERCK & REDSON
EST. 1940
CAMPUSES: DOWNTOWN ATHLETICS
33 SOUTH BROAD STREET, SUITE 101, PHILADELPHIA, PA 19104
101 W. NORTH ST. PHILADELPHIA, PA 19107
www.derckredson.com (215) 562-1000

TYPICAL DETAILS
AMENDED PRELIMINARY / FINAL SITE DEVELOPMENT PLAN
FAIRLEIGH DICKINSON ATHLETIC FIELDS
FAIRLEIGH DICKINSON UNIVERSITY
100 SOUTH BROAD STREET, SUITE 101, PHILADELPHIA, PA 19104
MADISON BOROUGH, MORRIS COUNTY, NEW JERSEY

REVISIONS:
No. DATE DESCRIPTION OF CHANGES

DATE: 03/26/2020
PROJECT NO: 19-42
DRAWN BY: MRM
PK: MRM
PIC: JMS

DRAWING NO. S-201

9/20/2010 10:34:39 PM